

PUBLISHED BY

INTECH

open science | open minds

World's largest Science,
Technology & Medicine
Open Access book publisher



2,900+
OPEN ACCESS BOOKS



99,000+
INTERNATIONAL
AUTHORS AND EDITORS



92+ MILLION
DOWNLOADS



BOOKS
DELIVERED TO
151 COUNTRIES

AUTHORS AMONG
TOP 1%
MOST CITED SCIENTIST



12.2%
AUTHORS AND EDITORS
FROM TOP 500 UNIVERSITIES



Selection of our books indexed in the
Book Citation Index in Web of Science™
Core Collection (BKCI)

Chapter from the book *Progress in Biomass and Bioenergy Production*

Downloaded from: <http://www.intechopen.com/books/progress-in-biomass-and-bioenergy-production>

Interested in publishing with InTechOpen?
Contact us at book.department@intechopen.com

Thermal Plasma Gasification of Biomass

Milan Hrabovsky
Institute of Plasma Physics ASCR
Czech Republic

1. Introduction

Since the 1980s applications of thermal plasmas experienced an important increase. In the 1990s fundamental research led to great progress in the understanding of the basic phenomena involved, and to a renewed interest in applying thermal plasmas to material processing and waste treatment. The application of plasma torches for environmental purposes is a relatively new process. Thermal plasma offers unique capability of carrying extremely high energy by small amount of plasma and ensures high heat transfer rates to treated materials. All materials can be decomposed if they are brought into contact with plasma.

Generators of thermal plasma (plasma torches) operate simultaneously as a plasma-chemical and a thermal apparatus. The electrical energy of the torches goes into the plasma which transfers its energy to the substances to be treated, thereby triggering a dual simultaneous reaction process in the plasmachemical reactor: the organic compounds are thermally decomposed into their constituent elements (*syngas* with more complete conversion of carbon into gas phase than in incinerators), and the inorganic materials are melted and converted into a dense, inert, non-leachable vitrified slag, that does not require controlled disposal. Therefore, it can be viewed as a totally closed treatment system.

While decomposition of waste and dangerous materials in thermal plasmas has been intensively studied in the last decade and industrial scale systems for treatment of various types of waste has been installed, plasma gasification of biomass is newly appearing application. For this application, the principal goal of the technology is production of fuel gases, principally mixture of carbon monoxide and hydrogen, called *syngas*. Thermal plasma offers possibility of decomposition of biomass by pure pyrolysis in the absence of oxygen, or with stoichiometric amount of oxygen (gasification) to produce high quality *syngas*, with high content of carbon monoxide and hydrogen and minimum presence of other components. As production of fuel gas is the main goal of the technology, an energy balance of the process is thus much more important than in case of waste treatment, where the principal goal is material decomposition.

Gasification is a process by which either a solid or liquid carbonaceous material, containing mostly chemically bound carbon, hydrogen, oxygen, is reacted with air or oxygen. The reactions provide sufficient exothermic energy to produce a primary gaseous product containing mostly CO, H₂, CO₂, H₂O(g), and small content of higher hydrocarbons. Heat

from external sources is usually supplied into the reactor to control the process and the reaction temperature, but most of heat for realization of the reaction usually comes from calorific value of biomass. In case when thermal decomposition of biomass is realized under the action of externally supplied heat and without any oxidant, we speak about pyrolysis. Especially pyrolysis is particularly well adapted to the valorization of lignocellulosic products such as wood or straw with good control of parameters of the process (gas composition, formation of tar) to maximize the production of hydrogen or syngas.

Principal problem of common biomass gasification technologies, based on the reaction between a heated carbon source with limited amounts of oxygen, consists in production of tar, which is formed from complex molecules of hydrocarbons created during the process. The gas from low temperature gasification typically contains only 50% of the energy in syngas components CO and H₂, while the remainder is contained in CH₄ and higher aromatic hydrocarbons [Boerrigter 2005]. Moreover, the syngas is diluted by CO₂ produced by partial oxidation process. The possibility of control of syngas composition in classical technologies is limited. The necessity of production of clean syngas with controlled composition leads to technologies based on external energy supply for material gasification.

Plasma pyrolysis and gasification for production of syngas is an alternative to conventional methods of biomass treatment. Plasma is a medium with the highest energy content and thus substantial lower plasma flow rates are needed to supply sufficient energy compared with other media used for this purpose. This results in minimum contamination and dilution of produced syngas by plasma gas and easy control of syngas composition. The process acts also as energy storage – electrical energy is transferred into plasma energy and then stored in produced syngas. The main advantages are better control of composition of produced gas, higher calorific value of the gas and reduction of unwanted contaminants like tar, CO₂, CH₄ and higher hydrocarbons. The other advantage of plasma is wide choice of treated materials. As energy for the process is supplied by plasma and chemical reactions in the reaction products are not primary source of energy, the process can be applied for wide choice of organic materials and biomass. For evaluation of technical and economic feasibility of plasma treatment these advantages must be taken into account together with higher energy consumption of plasma technology.

Plasma treatment offers better control of process temperature, higher process rates, lower reaction volume and especially optimum composition of produced syngas. Plasma pyrolysis or gasification exploits the thermochemical properties of plasma. The particles kinetic energy in the form of heat is used for decomposing biomass. In addition, the presence of charged and excited species renders the plasma environment highly reactive which can catalyses homogeneous and heterogeneous chemical reactions. The main advantage of plasma follows from much higher enthalpy and temperature of plasmas compared to the ones of gases used in conventional methods. Thus, substantially lower plasma flow rates can carry sufficient energy for the process and composition of produced syngas is not much influenced by plasma gas composition and moreover, substantially less energy is consumed to heating of plasma to reaction temperature. These advantages are especially noticeable in case of plasma generated in water stabilized plasma torches, which are characterized by extremely high enthalpies and low plasma mass flow rates. Compared to non-plasma methods the advantages of plasma gasification can be summarized as follows:

- Energy for gasification is supplied by plasma rather than energy liberated from combustion and thus it is independent of the treated substances, providing flexibility,

- fast process control, and more options in process chemistry. Broad range of biomass feedstock, incl. biodegradable fraction of waste, can be thus gasified.
- No combustion gases generated in conventional autothermal reactors are produced.
 - The temperature in the reactor can be easily controlled by control of plasma power and material feed rate.
 - As sufficiently high temperatures and homogeneous temperature distribution can be easily maintained in the whole reactor volume, production of higher hydrocarbons, tars and other complex molecules is substantially reduced.
 - High energy density and high heat transfer efficiency can be achieved, allowing shorter residence times and large throughputs.
 - Highly reactive environment and easy control of composition of reaction products.
 - Low thermal inertia and easy feedback control.
 - Much lower plasma gas input per unit heating power than the gas flow of classical reactors and thus lower energy loss corresponding to the energy necessary for heating of plasma to reaction temperature; also lower amount of gases diluting produced syngas.
 - Smaller plants than for conventional reactors due to high energy densities, lower gas flows, and volume reduction.

2. Thermodynamic analysis of plasma gasification of biomass

Principally all carbon and hydrogen atoms from biomass can be used for syngas production if biomass is heated to sufficiently high temperature. Maximum biomass to syngas conversion efficiency is achieved if all carbon is oxidized to CO. As most of biomass materials contain more carbon atoms than oxygen atoms, some oxygen has to be added to gasify all carbon. This can be done by addition of oxygen, air, steam or CO₂.

For the energy balance analysis, following three processes are taken into account:

- a. Gasification with addition of steichiometric amount of O₂

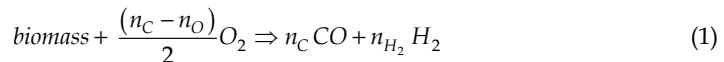

- b. Gasification with steichiometric amount of steam

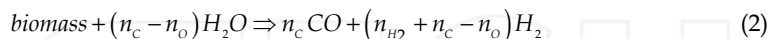

- c. Gasification with steichiometric amount of CO₂

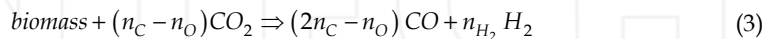

where $n_C = c/M_C$, $n_{\text{H}_2} = h/2M_H$ and $n_O = o/M_O$ are molar concentrations of carbon, hydrogen and oxygen in biomass with mass fractions of carbon, hydrogen and oxygen equal to c , h and o , respectively.

The power balance of the process can be written as

$$\Delta Q_r = \eta W_{\text{torch}} - P_{\text{react}}(T_r) - Q_{\text{gas}}^{\text{out}}(T_r) - Q_{\text{sol}}^{\text{out}}(T_r) - Q_{\text{pl}}^{\text{out}}(T_{\text{pl}} \geq T_r) \quad (4)$$

where ΔQ_r is power available for gasification, η is efficiency and W_{torch} power of the torch, P_{react} power loss to the reactor wall, Q_{gas} , Q_{sol} and Q_{pl} are power losses carried out of the

reactor by produced gases, solids and plasma, respectively. These power losses are dependent on temperature in the reactor T_r and the temperature of plasma gas leaving the reactor T_{pl} . The temperature T_{pl} is equal to T_r if complete mixing and heat transfer from plasma to treated material during residence time in the reactor is ensured.

The terms on the right hand side of equation (4) are determined by the torch power and its efficiency, by the construction of plasma reactor and by the reaction temperature T_r . The reaction temperature needed for biomass gasification can be determined from calculation of temperature dependence of composition of products of reactions (1) – (3). Due to high temperature in plasma reactor, we can assume that all reaction components in plasma reactor are in thermodynamic equilibrium. Under this assumption we can calculate the composition of reaction products from thermodynamic computations.

Fig. 1 presents the temperature dependence of composition of system containing mass fractions of carbon, hydrogen and oxygen corresponding to fir wood. The equilibrium composition of this heterogeneous system was calculated using the method described in [Coufal 1994], the input data for calculations of standard reaction enthalpy and standard thermodynamic functions of system components were taken from database [Coufal 2005]. It can be seen that wood is decomposed into hydrogen, carbon monoxide and solid carbon with small amount of other components at temperatures above 1 200 K. The presence of solid carbon, which in gasification reactors leads to formation of char, can be suppressed by addition of gas containing oxygen. To maintain high concentrations of CO and H₂ in the produced gas, it is advantages to use oxygen, carbon dioxide or steam as oxidizing media.

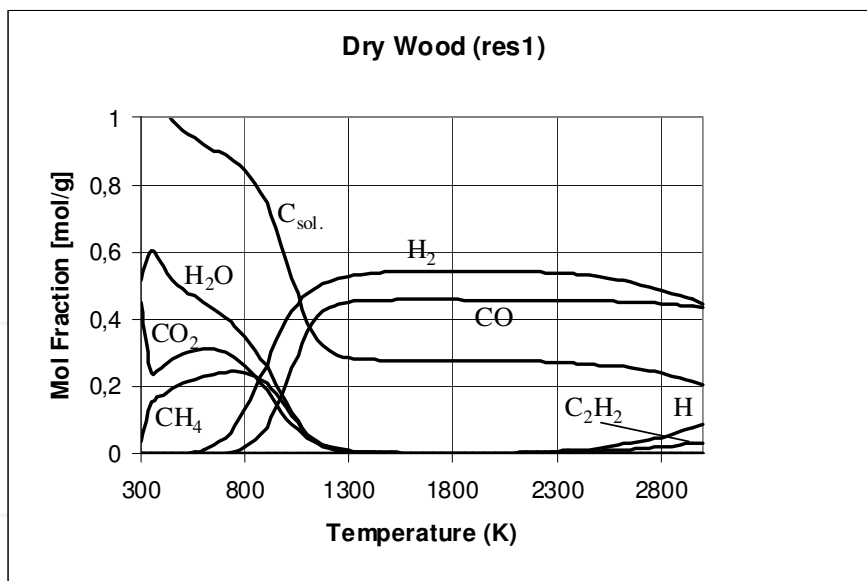

Fig. 1. Composition of products of wood pyrolysis. The mass ratios of components in wood: carbon $c = 0.511$, hydrogen $h = 0.064$, oxygen $o = 0.425$

Fig. 2 shows the composition of products of gasification of wood with addition of CO₂ and oxygen. The components considered in the computation correspond to the experimental

conditions described in the paragraph 4. Mixture of oxygen and carbon dioxide was used as an oxidizing medium for gasification of fir wood, the atmosphere in the reactor contained also steam plasma with small amount of argon supplied into the reactor by plasma torch. It can be seen that composition of produced syngas changed substantially due to the addition of other components. It can be seen in Figs. 1 and 2 that optimum composition of syngas with high concentration of H_2 and CO is reached at temperatures higher than 1200 K. As all power losses specified in equation (1) are increasing with temperature T_r , it will be optimal for energy balance to keep reactor temperature close to temperature 1 200 K.

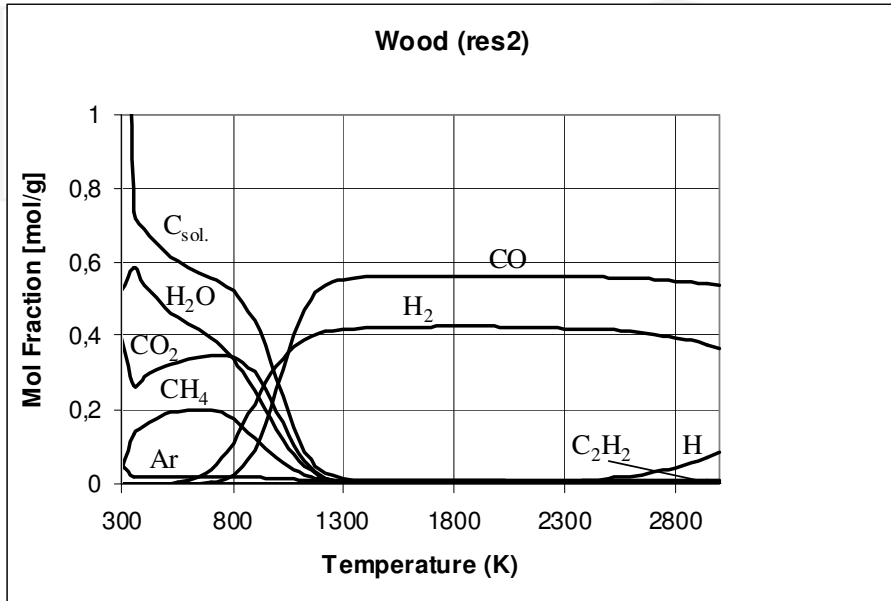

Fig. 2. Composition of products of wood gasification. The mass ratios of components in wood: $c = 0.511$, $h = 0.064$, $o = 0.425$. Wood 47 kg/h, humidity 6.5%, argon 13.55 slm, water plasma 18 g/min, CO_2 115 slm, O_2 30 slm.

The power available for material gasification ΔQ_r determines maximum possible feed rate of the material. We calculate energy Δh_r needed for realization of reactions represented by equations (1), (2), (3). As values representing heat of formation of biomass are not generally known, we calculate the heat Δh_r from known heats of combustion of cellulosic materials using the scheme in Fig. 3. The scheme in Fig. 3 corresponds to the reaction (1). The heat of gasification, i.e. production of syngas with composition $n_c CO + n_{H_2} H_2$, is calculated as the difference of heat of combustion $\Delta h_{c, net}$ and heat of combustion of syngas $\Delta h_{c, syng}$

$$\Delta h_{gas} = \Delta h_{c, net} - \Delta h_{c, syng} \quad (5)$$

The heat of combustion of cellulosic materials can be calculated from the equation [Dietenberger 2002]

$$\Delta h_{c, net} = 13.23 r_0 [kJ / g] \quad (6)$$

where r_0 is external oxygen mass fraction needed for complete combustion

$$r_0 = (8/3)c + 8h - o \tag{7}$$

The heat of combustion of syngas (LHV) produced by complete gasification of wood can be expressed as

$$\Delta h_{c,syng} = n_C (\Delta_f H^0(CO_2) - \Delta_f H^0(CO)) + n_{H_2} \Delta_f H^0(H_2O) \tag{8}$$

where ΔH^0 are heats of formation of individual molar components.

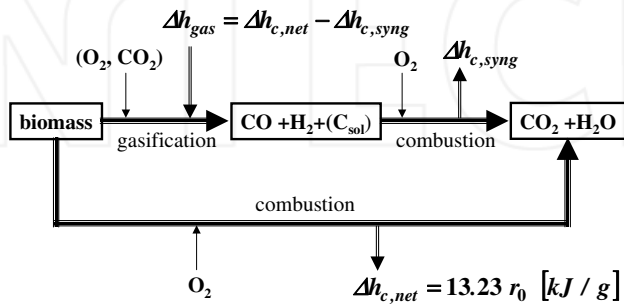

Fig. 3. Scheme of reactions for determination of reaction heat for biomass gasification.

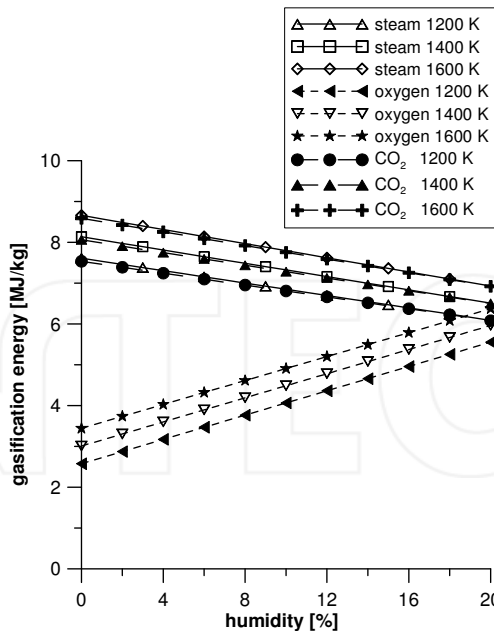

Fig. 4. Energy for gasification of wood for oxygen, steam and CO₂ process. Mass ratios of components in wood: $c = 0.511$, $h = 0.064$, $o = 0.425$.

In case of reactions (2) and (3), the reaction heat Δh_r includes also heat of dissociation of H_2O and CO_2 . For humid biomass also heat of dissociation of water in the biomass must be taken into account. As reaction can be realized at temperature T_r , the total heat for gasification is given by the sum

$$\Delta h_r = \Delta h_{gas} + \Delta H \quad (9)$$

where Δh_{gas} is given by (4) and ΔH is heat needed for heating of components on the right hand side of equations (1-3) from standard temperature to the reaction temperature T_r .

In Fig. 4 the total external energy needed for gasification of wood by processes (1) - (3) is plotted in dependence on material humidity for three reaction temperatures T_r . The humidity of wood is given by the weight percentage of water in the material. The energy for process with addition of steam (2) and CO_2 (3) are almost the same, which is related to little difference in dissociation energies of water and CO_2 .

The ratio of energy obtained by combustion of syngas (LHV) to the energy needed for its production is plotted in Fig. 5 against wood humidity. It can be seen that LHV of syngas produced from gasification of dry wood is up to 8 times higher than the heat spent for its production, for wood with 10% humidity this ratio is 5. If we consider torch efficiency 0.6 and the sum of power losses defined in (4) about 13% of the torch power, which corresponds to the experimental values measured in gasification experiments described in the paragraph 4, the ratio of LHV of syngas to total energy needed for its production is 3.6 for dry wood and 2.35 for wood with 10% humidity for reaction temperature 1300 K. As all power losses in the equation (4) for ΔQ_r are losses to the cooling water of the torch and the reactor, the real power gain after recuperation of heat in a cooling system could be even higher. If these numbers are compared with the conventional autothermal reactors, where only very low

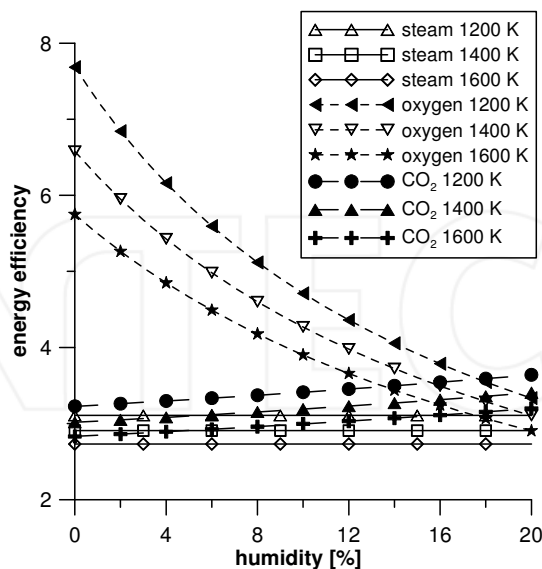

Fig. 5. Energy efficiency of gasification of wood for oxygen, steam and CO_2 processes. Mass ratios of components in wood: $c = 0.511$, $h = 0.064$, $o = 0.425$.

power is supplied to ignite the process of partial combustion, the energy gain in plasma systems is smaller. However, the LHV of produced syngas for autothermal reactors is usually between 35% and 60% of its theoretical value, and moreover, quality of produced syngas is low especially due to the production of tars and other contaminants.

The substantial advantage of plasma treatment is in reduction of mass flow rate of gasifying medium compared to the flow rate of gases used for non-plasma gasification. Thus, in case of plasma gasification, the produced syngas is less diluted by gas supplied into the reactor and has higher heating value. Also the power losses connected with the heating of gasifying medium to the reaction temperature are reduced. The ratio of mass of plasma, or gas at lower temperatures, needed for supply of energy Δh_i for complete gasification of wood, to the mass of wood, is plotted in dependence on gasifying medium temperature in Fig. 6 for nitrogen, oxygen and steam. The curves were calculated from thermodynamic equilibrium enthalpies of three gases [Boulos 1994, Krenek 2008] and from the total energy of gasification determined above. For temperatures lower than 3000 K the ratio is close to 1. Thus, for gasification with hot air (the amount of needed gas will be close to the values for nitrogen), almost half of the weight of produced syngas is air and thus syngas is diluted by high percentage of nitrogen (approximately 39% of weight of produced syngas). For comparison with plasma systems: for steam plasma with input temperature 16 000 K, which is the temperature corresponding to experiments described in paragraph 4, this ratio is less than 0.02 and thus almost undiluted syngas is produced.

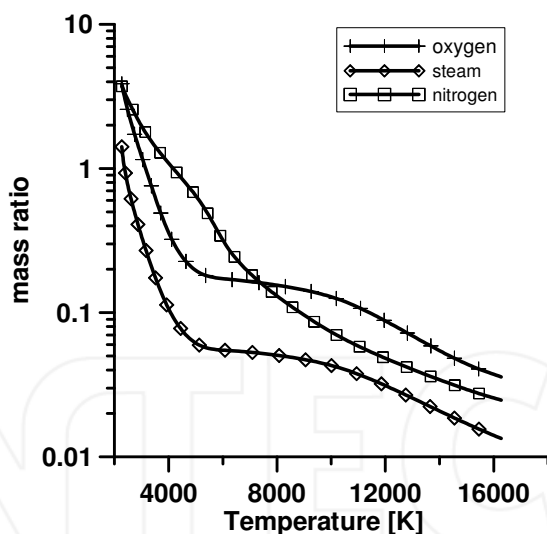

Fig. 6. Ratio of mass of gas carrying energy Δh_i for complete gasification of wood, to the mass of wood, in dependence on gas temperature.

3. Kinetics of gasification

Exact theoretical description of the plasma gasification process should be based on fluid dynamic model of plasma-material interaction, model of heat transfer to the material, its heating and volatilization as well as on description of kinetics of chemical reactions in the

reactor. We will describe here simple model of gasification kinetics based on solution of Arrhenius equation describing volatilization of material at given temperature together with equations describing heat and mass transfer between reactor atmosphere and surface of material.

The rate of biomass volatilization is commonly described by Arrhenius equation

$$\dot{m} = A \exp(-E / RT_s) \quad (10)$$

which determines dependence of volatilization rate m on temperature of material surface T_s . Frequency factor A and activation energy E were determined for various biomass materials, R is universal gas constant.

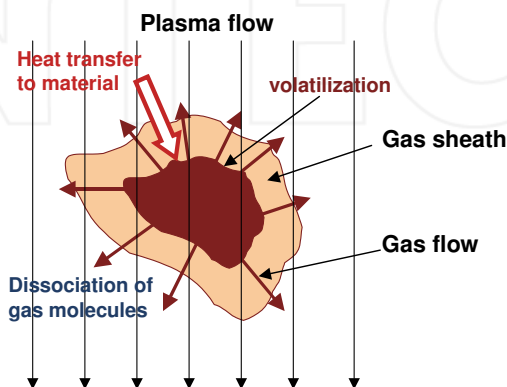

Fig. 7. Particle of gasified material with sheath of gas produced by volatilization.

In plasma gasification the heat flux to the gasified particles and thus the volatilization rate are extremely high and the sheath of gas, produced by gasification of particle, is formed. The conditions around particle of material are schematically shown in Fig. 7. The heat transfer through the sheath substantially influences the gasification rate. For description of the heat transfer we use the film model [Bird 2002]. Heat flux through the sheath created around spherical particle with surface temperature T_s is given by the equation

$$q_0 = \frac{\dot{m}C_p(T_r - T_s)}{e^{\frac{\dot{m}C_p}{h}} - 1} \quad (11)$$

where $\dot{m}(\text{kg} / \text{s} \cdot \text{m}^2)$ is volatilization rate, T_r is temperature in the reactor out of the sheath, C_p is specific heat and h heat transfer coefficient, both corresponding to local conditions in the sheath. We will approximate the heat transfer coefficient by relation for heat transfer to the sphere in flowing fluid [Bird 2002]

$$h = \frac{k \cdot Nu}{D} = \frac{k}{D} \left(2 + 0.6 Re^{1/2} Pr^{1/2} \right) \quad (12)$$

where Nu is Nusselt number, Re Reynolds number and Pr Prandtl number, D is diameter of the sphere and k thermal conductivity within the sheath.

The relation between volatilization rate and the heat flux is given by the energy balance equation

$$q_0 = \dot{m} \cdot \Delta h_{gas} \quad (13)$$

where Δh_{gas} is energy needed for gasification, which is given by equation (5).

From (12) and (13) we get following relation between mass gasification rate and difference of temperatures in the reactor and at the particle surface:

$$\dot{m} = \frac{h}{C_p} \ln \left(\frac{C_p}{\Delta h_{gas}} (T_r - T_s) - 1 \right) \quad (14)$$

By solving equations (11) and (14) we can obtain dependence of volatilization rate and surface temperature T_s on temperature in the reactor T_r and the particle diameter D . Calculated dependences are presented in Figs. 8 and 9 for various diameters of spherical particles. The computations were made for input parameters characteristic for wood ($c=0.511$, $h=0.064$, $\sigma=0.425$, $A=7.7 \cdot 10^6 \text{ s}^{-1}$, $E=1.11 \cdot 10^5 \text{ J/mol}$) and sheath values of transport and thermodynamic coefficients k , h , C_p corresponding to a mixture of hydrogen and CO with volume ratio 1:1 for zero relative velocity between particles and surrounding gas and averaged sheath temperature

$$T_{sheath} = \frac{(T_r - T_s)}{2} \quad (15)$$

Representation of wood gasification kinetics by one set of parameters A , E is simplification. Unfortunately the values corresponding to high gasification rates in plasma can not be found in the publications and thus we used values representing gasification of lignin [Miller 1997].

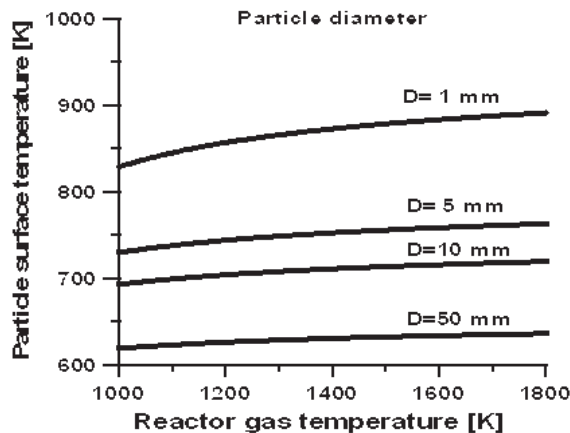

Fig. 8. Surface temperature of wood particles in dependence on reactor temperature for various particle diameters

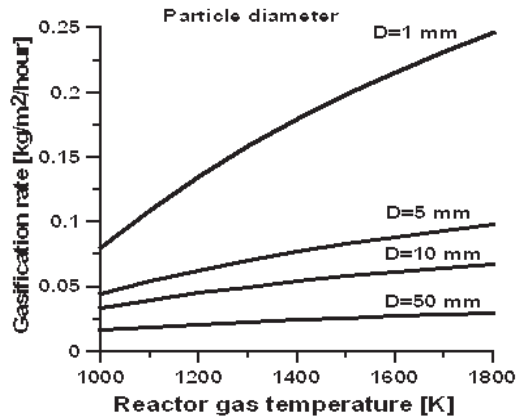

Fig. 9. Gasification rate of wood particles in dependence on reactor temperature for various particle diameters

It can be seen that the particle diameter substantially influences both the surface temperature and the gasification rate. Increase of the diameter results in reduction of heat transfer to the particle due to more intensive shielding of the particle by gas sheath formed from volatilized material. From the dependence of process rate on the size of particles a relation between throughput and minimum volume of the reactor can be estimated. The relation between total volume of particles of given diameter and gasification rate can be calculated from the equations (10) – (14). In Fig. 10 the ratio of total volume of particles to material throughput is plotted in dependence on reactor temperature for several particle diameters. A minimum reactor volume needed for given material throughput can be determined from these dependences assuming that reactor volume should be several times

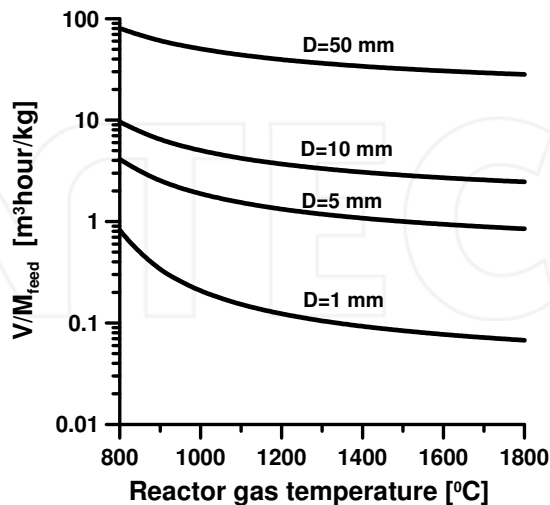

Fig. 10. Ratio of volume occupied by particles to total gasification rate

higher than volume occupied by particles to ensure good heat transfer to the particles. It can be seen from the Fig. 10 that needed volume of reactor rapidly increases with the size of the particles. The increase of the reactor volume leads to the increase of power loss $P_{react}(T_r)$ in equation (4). Optimal reactor volume can be determined on the basis of analysis of relations between process rate and power loss for given size of the particles.

4. Gasification of organic materials in steam plasma

Plasma gasification of biomass was studied in the recent years in several papers [Tang 2005, Brothier 2007, Hrabovsky 2006, Tu Wen Kai 2008, Tang 2005, Xiun 2005]. Up to now only laboratory scale experimental investigations of plasma biomass gasification have been performed. Production of syngas from wood in plasma generated in ac air plasma torches was studied in [Rutberg 2004]. In these experiments plasma with high flow rates and enthalpy not higher than 8 MJ/kg was used. The high flow rate of plasma ensures good mixing of plasma with treated material and a uniform temperature distribution in the reactor. However, the produced syngas contains plasma gas components, usually nitrogen and oxygen if air or nitrogen are used as plasma gases [Rutberg 2004, Zasyplin 2001]. The usage of mixtures of inert gas with hydrogen [Zhao 2001, Zhao 2003] eliminates this disadvantage but it increases the cost. In [Kezelis 2004] biomass was gasified in steam plasma, the usage of produced syngas as plasma gas in a special plasma torch is planned in [Brothier 2007]. This chapter presents the experimental results obtained in medium scale thermal plasma gasification reactor equipped by the gas-water dc plasma torch with arc power up to 160 kW.

4.1 Plasma gasification reactor

The experiments were performed on plasma reactor PLASGAS equipped by plasma torch with a dc arc stabilized by combination of argon flow and water vortex. The scheme of the experimental system is shown in Fig. 11. The torch power could be adjusted in the range of 90 - 160 kW. Power loss to the reactor walls was reduced by the inner lining of the reactor, which was made of special refractory ceramics with the thickness of 400 mm. The wall temperature 1100° to 1400°C could be regulated by the torch power and feeding rate of the material. Inner volume of the reactor was 0.22 m³. All parts of the reactor chamber were water-cooled and calorimetric measurements on cooling circuits were made. The material container was equipped with a continuous screw conveyor with controlled material feeding rate. Treated material was supplied into the reactor and was fed into plasma jet in the position about 30 cm downstream of the input plasma entrance nozzle at the reactor top. Inputs for additional gases for control of reactor atmosphere were at three positions in the upper part of the reactor. The gas produced in the reactor flowed through the connecting tube to the quenching chamber, which was created by a cylinder with the length of 2 m. At the upper entrance of the cylinder the gas was quenched by a spray of water from the nozzle, positioned at the top of the cylinder. The water flow rate in the spray was automatically controlled to keep the temperature of gas at the output of the quenching chamber at 300°C. The gas then flows into the combustion chamber where it is combusted in the flow of the air. To prevent destruction of ceramic insulation wall the reactor was pre-heated prior to the experiments for 24 hours to temperature about 950°C. Then the heating of the reactor walls to working temperature was made by plasma torch at arc power 110 kW.

The measuring system included monitoring of plasma torch operation parameters, temperatures in several positions inside the reactor and calorimetric measurements on cooling water loops. The temperature of inner wall of the reactor was measured in six positions by thermocouples. The flow rate of produced syngas was determined by two methods. Pitot flow meter was installed in the system downstream of the exit of quenching chamber and thus the total flow rate was measured of syngas and steam produced in quenching chamber with water spray. The flow rate was also determined from molar concentration of argon measured at the output of the reactor before quenching chamber in case when defined flow rate of argon was introduced into the reactor. Gas temperature was measured at the input and the output of the quenching chamber by thermocouples. The composition of produced gas was measured at the output of reactor before the gas enters the quenching chamber. The tube for collection of samples was cooled down by the water spray at the input of the quenching chamber.

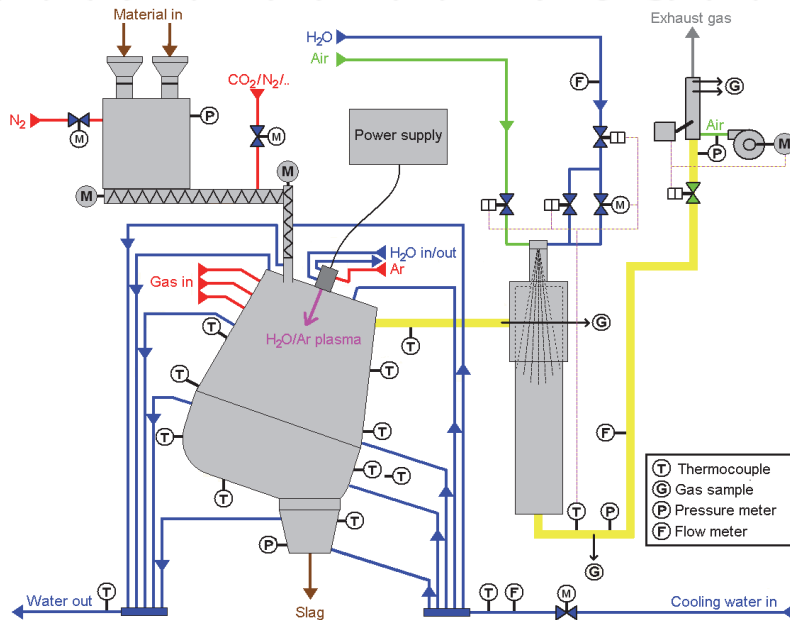

Fig. 11. Schematics of experimental reactor PLASGAS.

The main gas analysis was made by a quadruple mass spectrometer Balzers QMS 200. As the gas can contain some amount of steam which could after condensation block or damage the inputs of the mass spectrometer, the freezing unit was connected into the gas sample circuit.

Additional analyses of the composition of the produced syngas and the content of tar were made on samples of gas taken during the experiment by means of mass spectroscopy with cryofocusing, gas and liquid chromatography and FT infrared spectroscopy. Samples for tests of presence of tar in the gas were taken from the tube between the reactor and the quenching chamber. The samples were captured on the DSC-NH₂ adsorbent or silica gel and analyzed by gas and liquid chromatography. The content of tar was below the sensitivity of the method, which was 1 mg/Nm³.

4.2 Plasma generator with hybrid water/gas arc stabilization

Plasma was produced in the torch with a dc arc stabilized by combination of argon flow and water vortex. The torch generates an oxygen-hydrogen-argon plasma jet with extremely high plasma enthalpy and temperature. Typical arrangement of arc chamber with gas/water stabilization is shown in Fig. 12. The cathode part of the torch is arranged similarly like in gas torches. Gas is supplied along tungsten cathode tip, vortex component of gas flow that is injected tangentially, assures proper stabilization of arc in the cathode nozzle. Gas plasma flows through the nozzle to the second part of arc chamber, where arc column is surrounded by a water vortex. The chamber is divided into several sections, where water is injected tangentially. The inner diameter of the vortex is determined by the diameter of the holes in the segments between the sections. The sections with tangential water injection are separated by two exhaust gaps, where water is exhausted out of the arc chamber. Interaction of the arc column with the water vortex causes evaporation from the inner surface of the vortex. The steam mixes with the plasma flowing from the cathode section. An anode is created by a rotating copper disc with internal water cooling. Thus the arc column is composed of three sections. The cathode section is stabilized by a vortex gas flow. If gas with low enthalpy like argon is used, the voltage drop and power of this section is small. The most important section, which determines plasma properties, is the water-stabilized part, where the arc column interacts with the water vortex. The third part between the exit nozzle and the anode attachment is an arc column in a free jet formed from mixture of argon with steam.

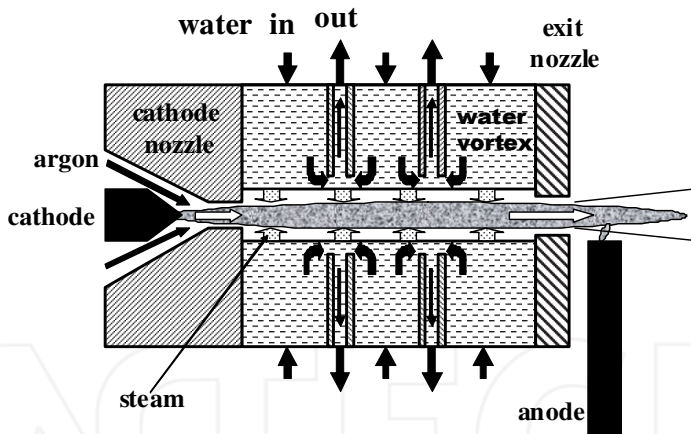

Fig. 12. Schematics of water/argon plasma torch.

As walls of stabilizing cylinder in the main arc chamber are created by water, arc can be operated at substantially higher power than in common gas stabilized torches. Figure 13 presents comparison of operation regimes of water stabilized torches and conventional gas stabilized torches, characterized by levels of arc power and plasma mass flow rate. Low mass flow rates of plasma for water torches follow from the energy balances of radial heat transfer. For gas torches mass flow rates can be controlled independently of arc power. However, lower limit of mass flow rate is given by a necessity to protect walls of arc chamber by gas flow. It can be seen that water plasma torches are characterized by very low mass flow rates. This fact results in high plasma enthalpies. Typical values of mean plasma

enthalpies for dc arc torches are shown in Fig. 13. Figure 14 presents enthalpies of steam plasma compared with mixtures of nitrogen and argon with hydrogen, which are commonly used in gas plasma torches. High enthalpy of steam plasma represents capacity of plasma to carry energy. The other positive property of steam plasma for plasma processing is high heat conductivity. Thus, extreme properties of plasma jets generated in water stabilized and hybrid stabilized arc torches follows both from the properties of steam plasma and from the way of stabilization of arc by water vortex.

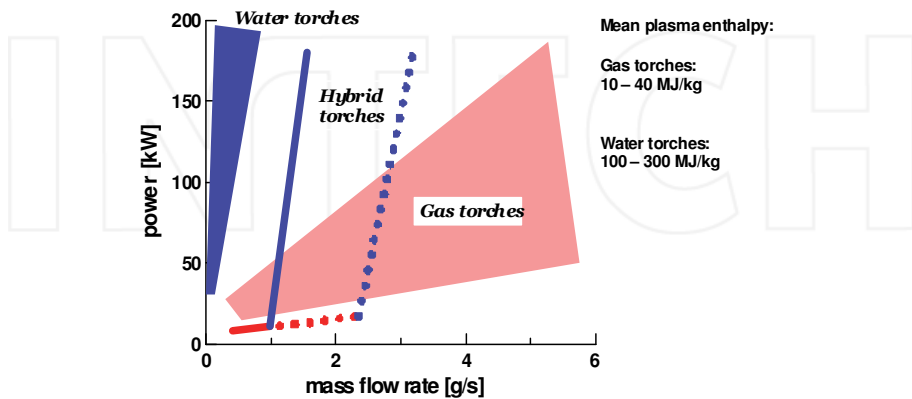

Fig. 13. Operation regimes of dc arc plasma torches.

The way how operation regime is established in a hybrid torch is illustrated in Fig. 13. In the cathode gas-stabilized section the power increases with gas flow rate slowly, if low enthalpy gas like argon is used (red part of characteristics in Fig. 13). Energy balance in the water

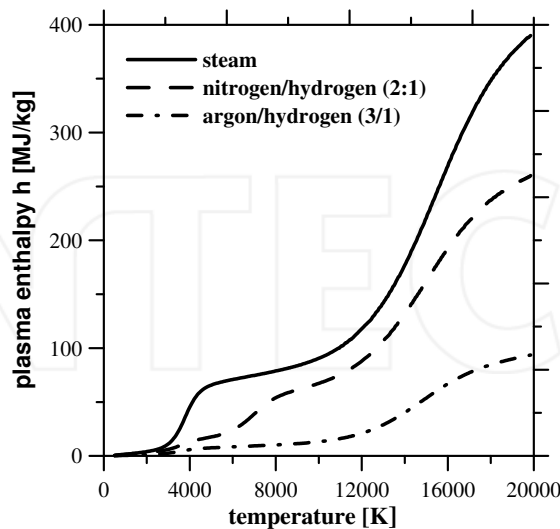

Fig. 14. Plasma enthalpy in dependence on temperature for steam and mixtures nitrogen/hydrogen (2:1 vol.) and argon hydrogen (3:1 vol.).

stabilized arc section is almost completely controlled by steam inflow and the arc in this section has electrical characteristics and power balances that are very close to the ones of water-stabilized torches. The power thus increases rapidly with mass flow rate as in the case of water torch (blue part of characteristics in Fig. 13).

High temperature plasma jet with high flow velocity is generated in the hybrid plasma torch. The centreline plasma flow velocity at the torch exit, which is increasing with both the arc current and the argon flow rate, ranges approximately from 1800 m/s to 7000 m/s. The centerline exit temperature is almost independent of argon flow rate and varies between 14 kK and 22 kK. In Fig. 15 measured profiles of plasma temperature for arc power 70 kW and 96 kW are presented. Temperature is increasing with arc current but does not depend much on argon flow rate, because thermal plasma parameters are determined by processes in water stabilized (Gerdien) arc part. Fig. 15 presents temperature profiles measured at position 2 mm downstream of torch nozzle. With increasing distance from the nozzle plasma jet temperature rapidly decreases due to mixing of plasma with ambient gas and due to intensive radial heat transfer to the jet surrounding.

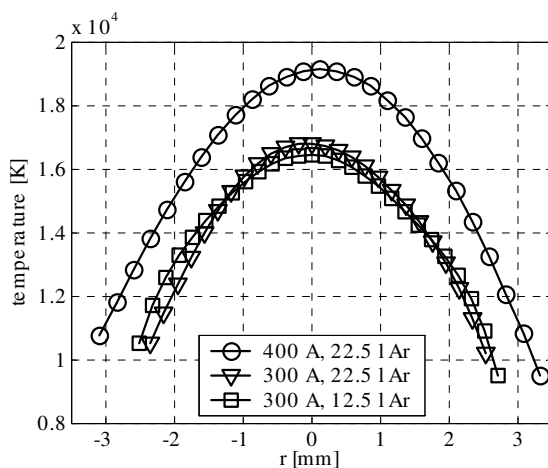

Fig. 15. Profiles of plasma temperature at the position 2 mm downstream of the torch exit for argon flow rates 12.5 and 22.5 slm for arc currents 300 A (70 kW) and 400 A (96 kW).

The torch was attached to the reactor at the reactor top. Plasma enters the reactor volume through the nozzle with diameter of 40 mm in the reactor top wall. The torch was operated at arc currents 350 A to 550 A and arc power 96 – 155 kW, plasma mass flow rates were in the range from 2.1 to 2.5 kg per hour.

4.3 Experimental results of plasma gasification of organic materials

Experiments with several materials at various conditions were performed with plasma reactor PLASGAS.

Table 1 presents examples of results obtained in experiments with gasification of wooden saw dust. The table gives values of basic operation parameters, i.e. plasma power, feed rate of wood, flow rates of gases added to the reactor (CO_2 and O_2) and averaged temperature T_r in the reactor. The temperature T_r given in the table is averaged temperature of the reactor

torch power	feed rate	CO ₂	O ₂	T _r	syngas	H ₂	CO	CO ₂	O ₂	Ar	CH ₄	calorific value
[kW]	[kg/h]	[slm]	[slm]	[K]	[m ³ /h]	%	%	%	%	%	%	[kW]
104	6.9	43	10	1360	7.13	27.7	60.8	5.4	0.7	4.9	0.5	21.11
104.3	6.9	20	10	1355	7.85	33.7	57.1	3.3	0.4	5.6	0.05	23.6
105.3	17	115	0	1345	30.42	31.5	59.5	4.9	0.1	2.3	1.6	92.2
106.1	17	115	30	1463	32.16	28.4	59.7	7.7	0.4	2.2	1.6	94.7
106.3	27.1	115	30	1417	34.41	22.3	68.3	2.4	4.8	1.4	0.8	105.4
152.5	27.1	115	30	1452		32.3	61.3	4.7	0.1	0.6	0.9	
95	28	16	0	1150	37.6	46.3	45.2	1.9	1.6	5.1	-	111.7
138	28	16	0	1200	32.6	42	44.3	3.4	2.5	7.8	0	101.6
107.7	47.2	115	30	1406	71.04	36	59.9	2.3	0.1	0.6	1.1	225.9
107.7	47.2	115	30	1364	76.36	37.3	60.1	1.8	0.1	0.2	0.4	246.3

Table 1. Basic operation parameters, composition, flow rate and calorific value of syngas produced by gasification of wood saw dust.

wall obtained as an average of inner wall temperatures measured at six positions in the reactor. The right hand side of the table presents flow rate of produced syngas, its composition and calorific value of syngas. The calorific value was calculated from measured flow rate of gas and its composition. It can be seen that for the highest feed rates the calorific value of produced syngas is almost 2.5 times higher than the torch power. The ratio of power available for material treatment (after all power losses were subtracted from the arc power) to total arc power increased with increasing arc power from 0.35 - 0.41 at arc power 95 - 100 kW to 0.41 - 0.46 for arc power higher than 130 kW for wall temperatures 1100 - 1200°C. The ratio was lower for higher wall temperatures. Most of the results in Table 1 were obtained at arc power 104 to 107 kW, some results for different power are also included. No effect of arc power on gas composition and flow rate was observed for tested feeding rates up to 47.2 kg/h. It can be concluded that maximum possible feeding rate at given power has not been reached.

The results of other test series of experimental gasification of wooden saw dust are presented in Table 2. The composition of produced syngas is compared with the composition determined by equilibrium computations which are presented in Fig. 2. In all test runs syngas with high concentrations of hydrogen and carbon monoxide was obtained. The concentration of CO₂ and CH₄ were small especially for higher feeding rates and higher flow rates of gases added for oxidation of surplus of carbon. The last column of Table 2 presents heating values of syngas calculated from the composition. It can be seen that the values of LHV and the composition are close to the results of equilibrium calculations.

	Test Parameters			Added gases		Syngas Composition						LHV _{syn} [MJ/m ³]
	Feed [kg/h]	T _r [K]	Power [kW]	CO ₂ [slm]	O ₂ [slm]	H ₂ %	CO %	CO ₂ %	O ₂ %	CH ₄ %	Ar %	
C	47	1350		115	30	42	56	0.3	0	0.4	1.0	11.72
E1	47.2	1364	108	115	30	37	60	1.8	0.1	0.4	0.2	11.76
E2	47.2	1420	108	115	30	36	59	2.9	0	1.5	0.6	11.84
E3	30	1280	110	15	0	43	44	7.2	0.1	1.3	3.3	10.81
E4	30	1360	110	15	0	42	49	4.7	0.1	1.7	2.5	11.33

Table 2. Measured (E) and computed (C) composition and LHV of syngas.

The differences between temperatures of inner wall measured at different positions within the reactor did not exceed 100°C. At all experiments the minimum measured wall

temperature was 1100°C. Under these conditions the change of wall temperature in the range of 1100 to 1450°C does not influence the flow rate and the composition of the produced gas, as can be seen in Tables 1 and 2.

The composition of produced gas was only slightly influenced by the material feeding rate and the power and was controlled by the ratio of mass of oxygen in supplied gases (O_2 , CO_2), added for complete oxidation of carbon, to the feed rate of material. This is illustrated in Fig. 16 where molar fractions of gas components are plotted in dependence on ratio of oxygen mass flow rate to the material feed rate.

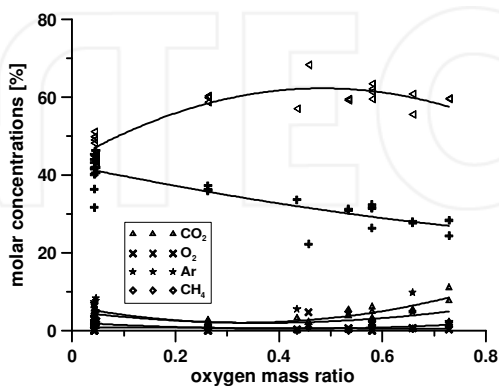

Fig. 16. Composition of syngas in dependence on mass ratio of oxygen in gases supplied into the reactor.

The degree of biomass gasification is characterized by the ratio of carbon content in syngas to the total amount of carbon supplied into the reactor in fed wood and in added gases. The ratio of carbon in gas phase to the supplied carbon is shown as carbon yield in Fig. 17. The ratios of carbon mass in syngas to the carbon mass in wood and to the total mass of supplied

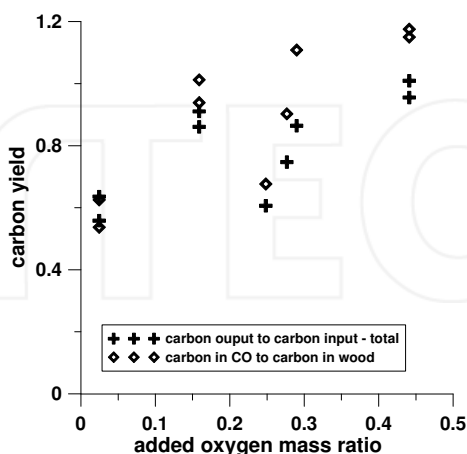

Fig. 17. Ratio of carbon in syngas to the supplied carbon in dependence on mass fraction of oxygen added into the reactor in O_2 and CO_2 .

carbon including supplied gas species are plotted in dependence on ratio of mass of oxygen added into the reactor in the gas species (O_2 and CO_2) to the mass of wood. The carbon yield, defined on the basis of mass of wood, can be higher than 1 as carbon from supplied gas (CO_2) is added to syngas. It can be seen that for higher feeding rates almost all carbon was gasified. Lower values of carbon yield for lower material feeding rates are probably related to weak mixing of plasma with material and thus less intensive energy transfer to the material. The mixing is more intensive at higher feeding rates due to substantially higher amount of gas produced in the reactor volume at high feeding rates. The flow within the reactor is almost completely controlled by material gasification, especially for higher feeding rates, because the amount of gas produced by gasification is up to $120 \text{ Nm}^3/\text{h}$ while the flow rate of plasma from the torch is $1.34 \text{ Nm}^3/\text{h}$.

The energy spent for the gasification of material at different feeding rates is shown in Fig. 18 in dependence on the feeding rate. Fig. 18 also gives the values of ratio of heating value of produced syngas (LHV), calculated from measured syngas composition and flow rate, to the energy spent for its production, corresponding to the torch power. It can be seen that for the highest values of the feeding rate this ratio, presented in Fig. 18 as energy gain, was 2.3.

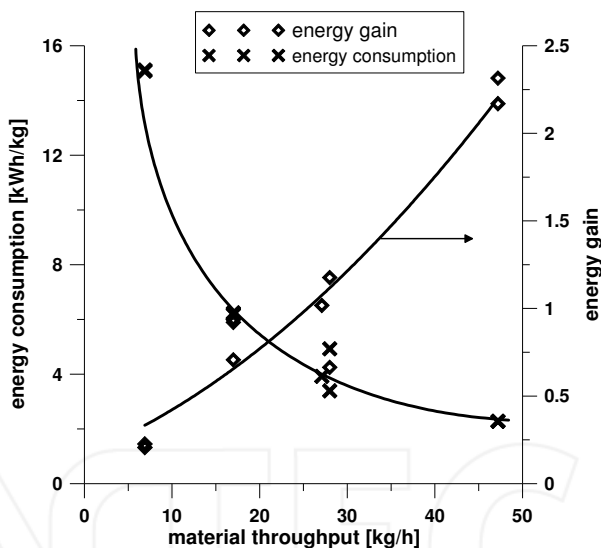

Fig. 18. Specific energy consumption for gasification and ratio of LHV of syngas to the torch power in dependence on feeding rate.

The results of analysis of tar content in produced syngas are shown in Table 3. The overall content of tar was lower than $10 \text{ mg}/\text{Nm}^3$, which was under the detection limit of used TCD. This occurred even with toluene, and it is obvious that concentration of tar in produced gas is really low in comparison with other gasification technologies. Especially in the case of lower feeding rates of treated material the tar content was minimal. Low tar content is caused mainly by the high temperatures in the reactor and the fast quenching as well as by high level of uv radiation in the entrance of output gas tube, which was positioned close to the input for plasma jet.

Plasma torch power [kW]	107	107	107
CO ₂ flow rate [slm]	5	10	60
Humidity of treated wood [w/w]	20.2	20.2	20.2
Wood flow rate [kg/hour]	10	20	50
Benzene [mg/Nm ³]	1,5	2,7	116,2
Toluene	< 1 mg/Nm ³		
Tar - SPE	< 10 mg/Nm ³		

Table 3. Content of benzene, toluene and tar in produced syngas.

Besides experiments with wood saw dust, gasification of several other organic materials was tested. Tables 4 and 5 show results of test runs of following four materials: wooden saw dust, wooden pellets 6 mm in diameter and 6 mm long, polyethylene balls of diameter 3 mm and waste polyethylene plastics composed of 80% high-density polyethylene and 20% low-density polyethylene. Gasification by reaction with CO₂, O₂ and mixture of the two gases was studied. Table 4 presents basic experimental parameters, feed rates of materials and flow rates of added gases. Arc current was 446 to 450 A and arc power between 130 and 140 kW. Small differences in arc current and power for various runs are caused by small fluctuations of arc voltage due to changes of temperature of water in the arc chamber. Composition of syngas determined from the analysis by mass spectrometer is shown in Table 5. Amount of carbon transferred into gas phase was determined from syngas flow rate and gas composition. The gas yield of carbon represented by the ratio of amount of C in syngas to total amount of carbon in supplied material and gases is given in Table 5.

	I [A]	P[kW]	material	[kg/h]	CO ₂ [slm]	O ₂ [slm]	T _r [°C]
1	449	138	wood	41,1		64	1362
2	448	138	wood	41,1	125		1355
3	449	137	wood	25,2	125	43	1368
4	449	137	wood	25,2	125		1341
5	449	137	wood	25,2	86		1337
6	450	140	pellets	30		64	1493
7	450	140	pellets	30	248		1383
8	450	140	pellets	60	248		1286
9	446	140	PE	5,3	210	80	1539
10	446	140	PE	10,6	210	80	1559
11	448	131	plastics	11,2	300		1397

Table 4. Experimental conditions and input parameters for several materials.

It can be seen that syngas with high concentrations of hydrogen and carbon monoxide was obtained in all runs. The CO₂ concentrations were small especially for wood saw dust and wood pellets (runs 4, 5, 7, 8), concentration of CH₄ was very low in all runs. Oxidation with CO₂ and O₂ led to the same composition (runs 1,2). Surplus of oxygen (run 3) resulted in increase of concentration of CO and reduction of H₂, probably due to formation of H₂O. Concentration of water in syngas could not be measured by mass spectrometer due to problems with condensation; water was removed in freezing unit. In the runs 5, 8 and 10 an

amount of supplied oxygen was close to stoichiometric values for oxidation of all carbon in material. Complete transformation of carbon into gas phase was found for wood saw dust and polyethylene. For wooden pellets and plastic waste the carbon yield was 0.7 – 0.8.

In all cases, like in case of wood saw dust, the content of tar and higher hydrocarbons in the produced gas was very low and substantially less than 10 mg/Nm³. This is lower than the tar content in most of non-plasma gasifiers, where the tar content for various types of reactors varies in the range from 10 mg/Nm³ to 100 g/Nm³.

	material	% H ₂	% CO	% CO ₂	%CH ₄	% O ₂	C _{out} /C _{in}
1	wood	44,8	39,2	15,0	0,9	0,1	1,0
2	wood	41,5	42,5	14,9	1,0	0,1	0,9
3	wood	34,6	51,4	12,6	0,4	1,0	1,0
4	wood	41,5	54,1	3,3	0,3	0,8	1,0
5	wood	43,6	52,0	3,3	0,3	0,8	1,0
6	pellets	48,1	40,0	11,0	0,1	0,8	0,7
7	pellets	36,5	59,1	3,4	0,1	1,0	0,8
8	pellets	41,5	52,7	4,8	0,2	0,8	0,8
9	PE	29,9	41,3	27,1	0,0	1,7	1,0
10	PE	35,3	41,5	21,7	0,1	1,4	1,0
11	plastics	41,6	49,7	7,4	0,0	1,3	0,7

Table 5. Composition of syngas and carbon yield for conditions in Table 4.

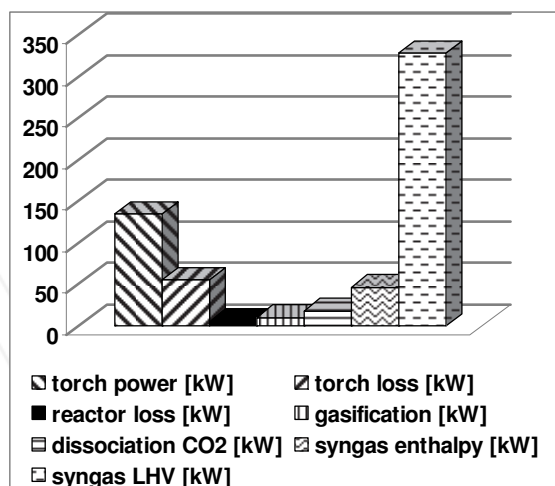

Fig. 19. Power balance of gasification of wooden pellets in the run 8.

Analysis of power balance for experimental run with the highest material feed rate (run 8) is shown in Fig. 19. Torch power, power loss in the torch, power loss to the reactor walls and total power spent for process of gasification were determined from current and voltage

measurements and calorimetric measurements on cooling circuits of the system. Power spent for dissociation of CO_2 was calculated from flow rate of added CO_2 , power corresponding to low heating value of syngas was calculated from measured composition and flow rate of syngas. Heating value of produced syngas is more than two times higher than power of the torch.

It can be seen that in case of gasification with CO_2 most of power needed for production of syngas was dissociation power of CO_2 . Energy needed for dissociation of CO_2 is deposited in calorific value of produced syngas. The process thus can act as an energy storage - electrical energy is transferred to plasma energy and then stored in produced syngas. This can be used for storage of energy produced by new renewable sources of electrical energy that are often characterized by large fluctuations of energy production. Moreover, the process offers utilization and transformation of CO_2 produced by industrial technologies.

5. Conclusions

The research of plasma biomass gasification has been started as a response for a need of more efficient utilization of biomass for energy and fuel production. Classical ways of biomass gasification, based on partial combustion, do not produce synthesis gas with quality demanded by advanced technologies of fuel and energy production, mostly due to contamination of syngas by CO_2 , methane, tars and other components. The necessity of production of clean syngas with controlled composition leads to technologies based on external energy supply for material gasification. Plasma is medium with the highest energy content and thus substantial lower plasma flow rates are needed to supply sufficient energy compared with other media used for this purpose. This result in minimum contamination of produced syngas by plasma gas and easy control of syngas composition. Especially high enthalpy steam plasma produced in water and water-gas torches offers excellent characteristics.

The experiments with gasification of wood, wooden pellets, polyethylene and plastic waste were performed on the reactor with hybrid gas-water plasma torch. The composition of produced syngas was close to the calculated equilibrium composition, determined for the case of complete gasification. The heating value of produced syngas was in good agreement with calculated equilibrium values. In all cases the content of tar and higher hydrocarbons in the produced gas was very low and usually less than 10 mg/Nm^3 . This is substantially lower than the tar content in most of non-plasma gasifiers, where the tar content for various types of reactors varies in the range from 10 mg/Nm^3 to 100 g/Nm^3 [Hasler 1999, Jun Han 2008].

It has been experimentally verified that for small particles and higher feeding rates all supplied material was gasified. Heating value of produced syngas was for the highest material feed rates more than two times of power of plasma torch. In case of gasification with carbon dioxide as oxidizing medium, most of power needed for gasification process was power for dissociation of CO_2 . The process can be used as an energy storage - electrical energy is transferred to plasma energy and then stored in produced syngas. This can be utilized for storage of energy produced by sources of electrical energy with large fluctuations of energy production. Moreover, the process offers utilization and transformation of CO_2 generated by industrial technologies.

If energy balances of plasma gasification are compared with the conventional autothermal reactors, where only very low power is supplied to ignite the process of partial combustion,

the energy gain in plasma systems is smaller. However, the LHV of produced syngas for autothermal reactors is usually between 35% and 60% of its theoretical value, and moreover, quality of produced syngas is low especially due to the production of tars and other contaminants. Thus, plasma can offer advantages if high quality syngas with high heating value is needed. Moreover, possibility of electrical energy storage can be utilized in combination with new renewable power production technologies.

6. Acknowledgment

The author gratefully acknowledges the financial support of the Grant Agency of the Czech Republic under the project No. 205/11/2070.

7. References

- Bird, R.B.; Stewart, W.E., Lightfoot, E.N. 2002. Transport Phenomena. J. Willey&Sons, Inc., New York/Chichester/Weinheim/Brisbane/Singapore/Toronto.
- Boerrigter H.; van der Drift, B. 2005. "Biosyngas" key-intermediate for production of renewable transportation fuels, chemicals and electricity. *ECN report ECN-RX-05-181*, presented 14th European Biomass Conf.&Exhibition, Paris.
- Boulos, M.I.; Fauchais, P., Pfender, E. 1994. Thermal Plasma Fundamentals and Applications. Plenum Press, New York-London.
- Brothier, M., et al. 2007. Syngas production from the biomass gasification by plasma torch. *Proc. of 18th ISPC* (ed. K Tachibana et al), Kyoto, Book of Abstracts: 193, full paper on CD.
- Coufal, O. 1994. Composition of the reacting mixture SF₆ and Cu in the range from 298.15 to 3000 K and 0.1 to 2 Mpa. *High Temp. Chem. Processes*, 3: 117-139.
- Coufal O.; Sezemsky P., Zivny O. 2005. Database system of thermodynamic properties of individual substances at high temperatures. *J. Phys. D: Appl. Phys.*, 38: 1265-1274.
- Dietenberger M. 2002. Update for combustion properties of wood components. *Fire Mater.*, 26: 255 – 267.
- Hasler P.; Nussbauer Th. 1999. Gas cleaning for IC engine applications from fixed bed biomass gasification. *Biomass and Bioenergy*, 16: 385-395.
- Jun Han; Heejoon Kim 2008. *Renewable and Sustainable Energy Reviews*, 12: 397- 416.
- Hrabovsky M.; Konrad M., Kopecky V., Hlina M. 2006. Pyrolysis of wood in arc plasma for syngas production. *J. of High Temperature Material Processes*, 10: 557-570.
- Kezelis R.; Mecius V., Valinciute V., Valincius V. 2004. Waste and biomass treatment employing plasma technology. *J. of High Temp. Mat. Process.*, 8: 273-282.
- Krenek P. 2008. Thermophysical properties of H₂O-Ar plasmas at temperatures 400-50000K and pressure 0,1 MPa. *Plasma Chem. Pl. Process*, 28: 107-122.
- Miller R.S.; Bellan J. 1997. A generalized biomass pyrolysis model based on superimposed cellulose, hemicellulose and lignin kinetics. *Comb. Sci. and Technol.*, 126: 97-137.
- Rutberg P.G.; Bratsev A.N., Ufimtsev A.A. 2004. Plasmochemical technologies for processing of hydrocarbonic raw material with syngas production. *J. of High Temp. Mat. Process.*, 8: 433-446.
- Tang L.; Huang H. 2005. Plasma pyrolysis of biomass for production of syngas and carbon adsorbent. *ENERGY & FUELS*, 19: 1174-1178.

- Tang L.; Huang H. 2005. Biomass gasification using capacitively coupled RF plasma technology. *Fuel*, 84: 2055-2063.
- Tu, Wen-Kai et al. 2008. Pyrolysis of rice straw using radio-frequency plasma. *ENERGY&FUELS*, 22: 24-30.
- Xiu S.N.; Yi W.M., Li B.M. 2005. Flash pyrolysis of agricultural residues using a plasma heated laminar entrained flow reactor. *BIOMASS BIOENERG*, 29: 135-141.
- Zasytkin I.M.; Nozdrenko G.V. 2001. Production of acetylene and synthesis gas from coal by plasma chemical methods. *Thermal Plasma Torches and Technologies*, Vol II., ed. O.P. Solonenko, Cambridge Interscience Publish.: 234-243.
- Zhao Z.L.; Huang H.T., Wu C.Z., Li H.B., Chen Y. 2001. Biomass pyrolysis in an argon/hydrogen plasma reactor. *Chem. Engineering & Technology*, 24: 197-199.
- Zhao Z.L. 2003. Plasma gasification of biomass in a downflow reactor. *Abstract of Papers of the American Chemical Society*, 226: U536-U536 048-FUEL Part 1.

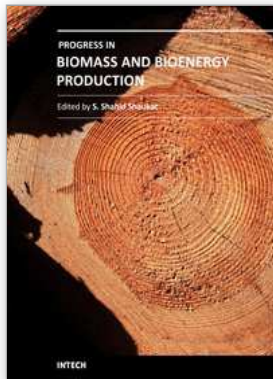

Progress in Biomass and Bioenergy Production

Edited by Dr. Shahid Shaukat

ISBN 978-953-307-491-7

Hard cover, 444 pages

Publisher InTech

Published online 27, July, 2011

Published in print edition July, 2011

Alternative energy sources have become a hot topic in recent years. The supply of fossil fuel, which provides about 95 percent of total energy demand today, will eventually run out in a few decades. By contrast, biomass and biofuel have the potential to become one of the major global primary energy source along with other alternate energy sources in the years to come. A wide variety of biomass conversion options with different performance characteristics exists. The goal of this book is to provide the readers with current state of art about biomass and bioenergy production and some other environmental technologies such as Wastewater treatment, Biosorption and Bio-economics. Organized around providing recent methodology, current state of modelling and techniques of parameter estimation in gasification process are presented at length. As such, this volume can be used by undergraduate and graduate students as a reference book and by the researchers and environmental engineers for reviewing the current state of knowledge on biomass and bioenergy production, biosorption and wastewater treatment.

How to reference

In order to correctly reference this scholarly work, feel free to copy and paste the following:

Milan Hrabovsky (2011). Thermal Plasma Gasification of Biomass, Progress in Biomass and Bioenergy Production, Dr. Shahid Shaukat (Ed.), ISBN: 978-953-307-491-7, InTech, Available from:
<http://www.intechopen.com/books/progress-in-biomass-and-bioenergy-production/thermal-plasma-gasification-of-biomass>

INTECH
open science | open minds

InTech Europe

University Campus STeP Ri
Slavka Krautzeka 83/A
51000 Rijeka, Croatia
Phone: +385 (51) 770 447
Fax: +385 (51) 686 166
www.intechopen.com

InTech China

Unit 405, Office Block, Hotel Equatorial Shanghai
No.65, Yan An Road (West), Shanghai, 200040, China
中国上海市延安西路65号上海国际贵都大饭店办公楼405单元
Phone: +86-21-62489820
Fax: +86-21-62489821